



HISTOGRAMME

FICHE TECHNIQUE

la CLÔTURE
FRANÇAISE
CRÉATEUR D'ESPACE



Caractéristiques détaillées

Modèle : Histogramme

Catégorie : brise-vue

Matières utilisées : PVC, Inox, Aluminium, Acier galvanisé

Hauteur : de 60 cm à 1,60 m

Coloris disponibles :

Blanc
Tons gris cérusé

Largeur du panneau : 2 m
dernier module ajusté sur-mesure.

Variantes :

Coupe droite / Coupe irrégulière

Composants :

Platines de fixation *Acier galvanisé*
Entretoises intermédiaires *PEHD*
Cache-platines *Aluminium*
Entretoises 5 cm *PEHD*
Entretoises 1 cm *PEHD*
Pièces de jonction *Inox*
Bouchons ronds *Aluminium*
Lisses 10 x 2 cm *PVC*
Bouchons plats pour lisse *PEHD*
Traverse horizontales 3 x 5 cm *Aluminium*

Conception : sur mesure

Conditionnement : en kit, pré-monté

Livraison : à domicile par transporteur

Enlèvement : au dépôt de Loriol-sur-Drôme



Résistance mécanique	_____	30 ans
Coloris blanc	_____	30 ans
Tons gris cérusé	_____	5 ans



Résistance
aux vents



Traitement
Anti-UV



Délai de
fabrication :
4 semaines

*Télécharger conditions de garanties contractuelles des produits
sur : www.la-cloture-francaise.fr/engagements-et-garanties

Dimensions

Hauteurs disponibles

- 0,600 m
- 0,800 m
- 1,000 m
- 1,200 m
- 1,400 m
- 1,600 m

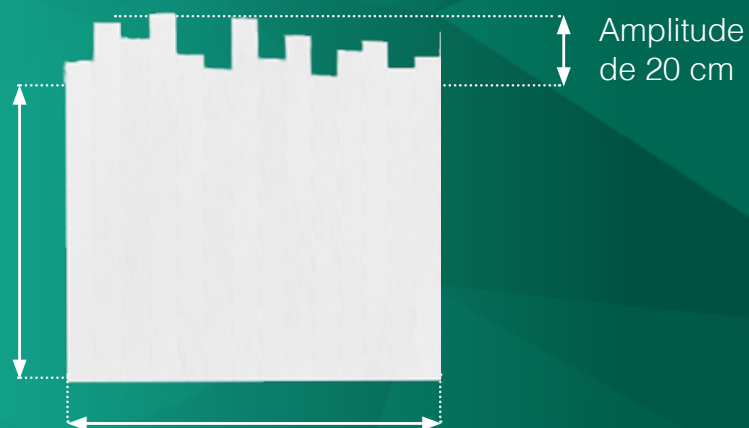

Largeur max : 2 m

Personnalisez votre projet

Variantes disponibles



Coupe droite

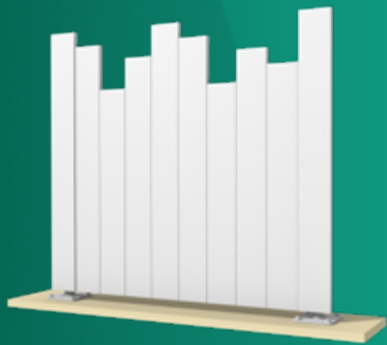

Coupe irrégulière

Coloris de clôture

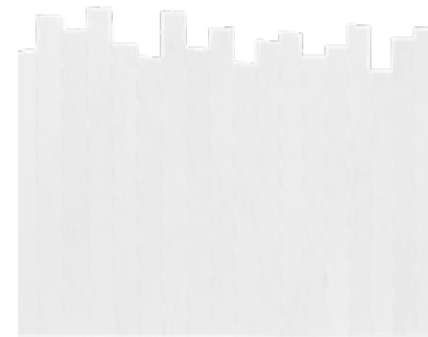

Blanc

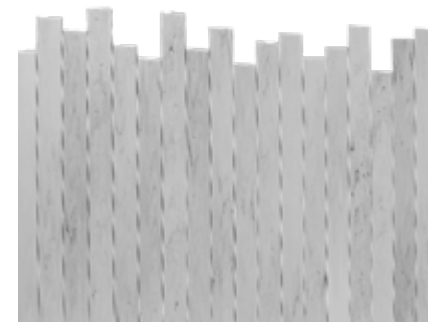

Tons gris cérusé

Composition

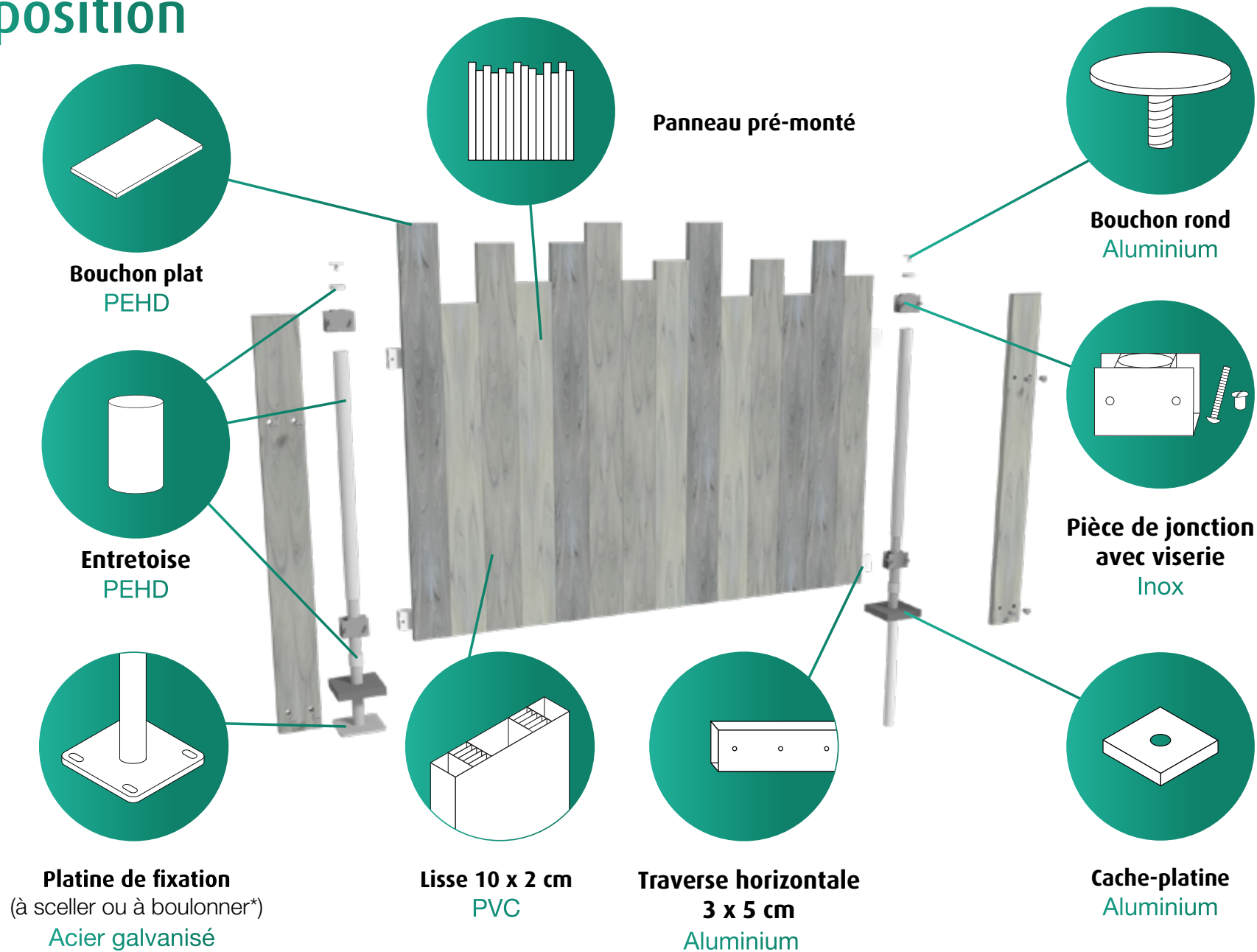

*Le choix du type de platines se fera selon la nature de votre sol et la hauteur de la clôture.

Fixation sur support creux

Platine à boulonner

Kit de scellement chimique

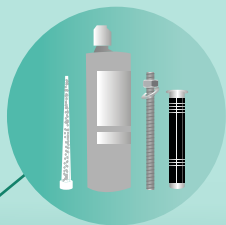

Ciment



Tube à sceller

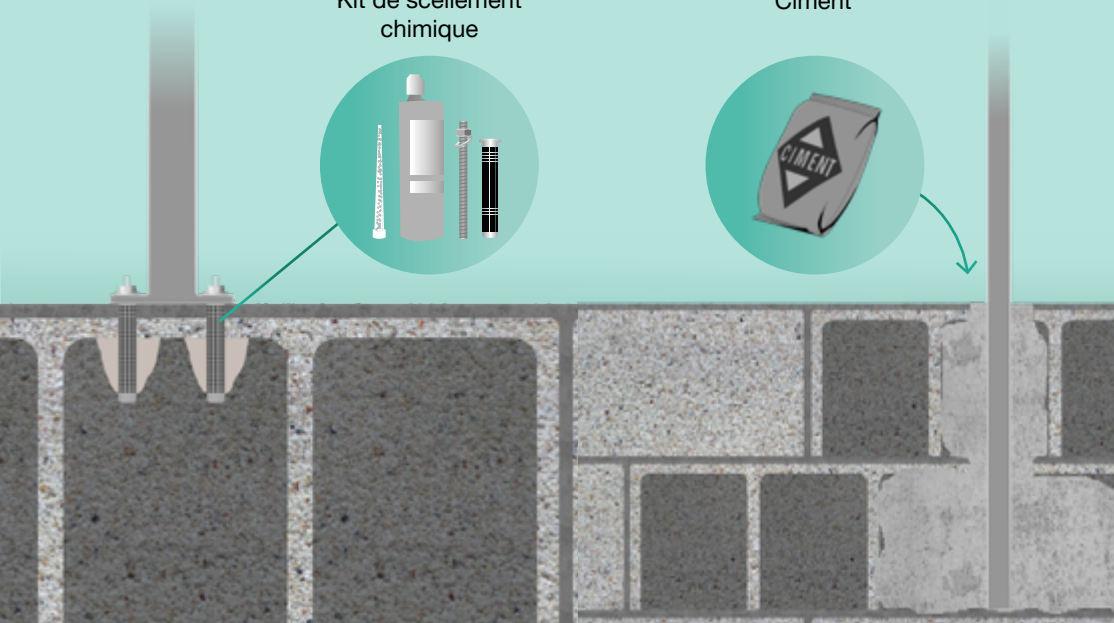

Fixation sur support plein

Réalisation d'un support béton pour la fixation de la platine ou le scellement du tube.

Boulon à expansion ou

Goujon d'ancrage

Plot beton

Tube à sceller

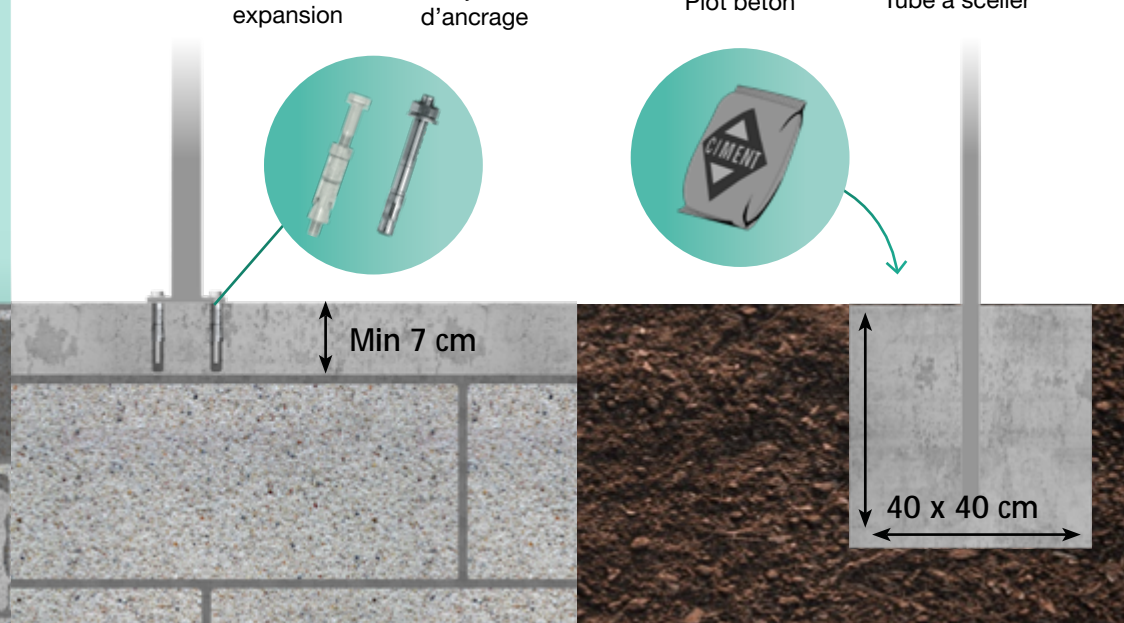
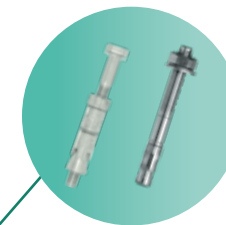

Tube à sceller

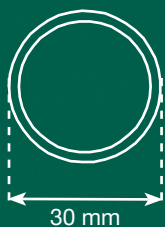

Platine à boulonner

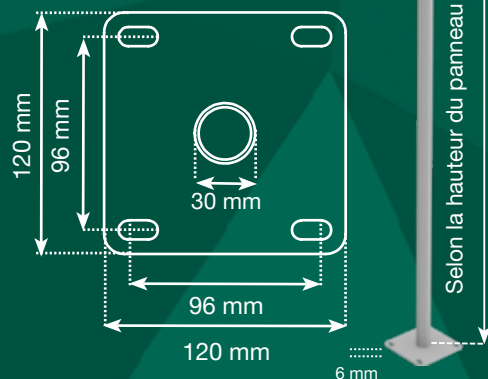

Type de platines

Hauteur clôture max jusqu'à **1,30 m**



Platine à boulonner

Hauteur clôture max jusqu'à **1,60 m**

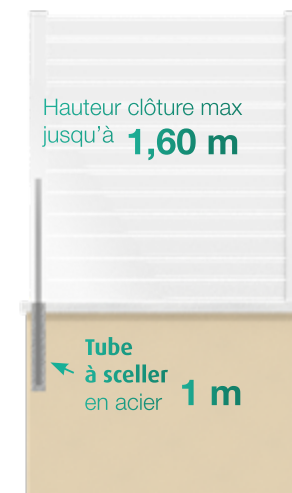

Tube à sceller en acier **1 m**

Hauteur clôture à partir de **1,60 m**



Tube à sceller en acier **2 m**

La Clôture Française

ZI Les Blâches
26270 LORIOI - FRANCE

Tél. 04 75 61 15 25
contact@la-cloture-francaise.fr



*Livraison dans toute
la France métropolitaine*